

C

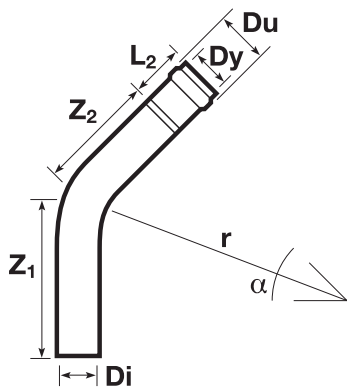

z	()	2
z	()	3
z	()	10
z /		12
z	()	15

*

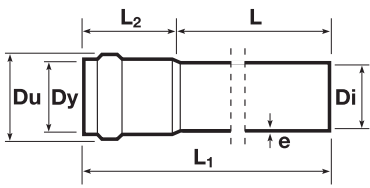

- ?
- d?
- Di ?
- DN
- Du ?
- Dy ()
- ? ()
- F
- ?
- k
- L
- L1
- L2 ?
- M
- ?
- R
- Rc
- Rp
- S?
- Z
- MRS (Minimum Required Strength)
- PE 80 8 (MRS 80)
- PE 100 10 (MRS 100)
- *

SDR PN

SDR	PN	PE	*
SDR		26	17
PE 80, PN 6,3			x
PE 80, PN 10			x
PE 100, PN 6,3		x	
PE 100, PN 10			x
PE 100, PN 16			x

*SDR (Standard Dimension Ratio) –
PN –

« »

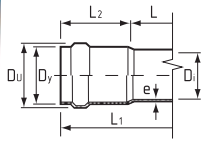

100

Z « »
Z :
:

Dy,		Di	() Du	e	L ()	L1	L2
PN 6							
75	201000075	70,6	95,4	2,2	6	6121	121
90	201000090	84,6	113,5	2,7	6	6125	125
110	201000110	103,6	136,7	3,2	6	6136	136
160	201000160	150,6	193,8	4,7	6	6154	154
200	201000200	188,2	238,7	5,9	6	6171	171
225	201000225	211,8	266,7	6,6	6	6184	184
250	201000250	235,4	295,1	7,3	6	6196	196
280	201000280	263,6	329,2	8,2	6	6225	225
315	201000315	296,6	370,7	9,2	6	6225	225
400	201000400	376,6	470,8	11,7	6	6256	256
500	201000500	470,8	588,4	14,6	6	6300	300
PN 10							
50	201001050	45,2	65,6	2,4	6	6108	108
63	201001063	57,0	83,2	3,0	6	6113	113
75	201001075	67,8	98,2	3,6	6	6121	121
90	201001090	81,4	116,7	4,3	6	6125	125
110	201001110	99,4	140,9	5,3	6	6136	136
160	201001160	144,6	199,8	7,7	6	6154	154
200	201001200	180,8	246,1	9,6	6	6171	171
225	201001225	203,4	275,1	10,8	6	6184	184
250	201001250	226,2	324,0	11,9	6	6196	196
280	201001280	253,2	339,2	13,4	6	6225	225
315	201001315	285,0	382,3	15,0	6	6225	225
400	201001400	361,8	485,6	19,1	6	6256	256
500	201001500	452,2	607,0	23,9	6	6300	300

125

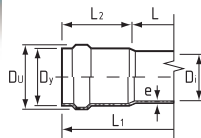

Z « »
Z :
:

Dy,		Di	() Du	e	L ()	L1	L2
PN 6							
110	201010110	104,6	133,4	2,7	6	6133	133
160	201010160	152,0	187,0	4,0	6	6145	145
200	201010200	190,2	228,8	4,9	6	6156	156
225	201010225	214,0	255,7	5,5	6	6152	162
250	201010250	237,6	284,0	6,2	6	6172	172
280	201010280	263,0	337,0	8,2	6	6175	175
315	201010315	299,9	352,9	7,7	6	6201	201
400	201010400	380,4	444,8	9,8	6	6212	212
500	201010500	475,0	576,0	12,3	6	6213	213
630*	201010630	599,2	-	15,4	12	-	-
PN 10							
110	201011110	101,6	133,4	4,2	6	6133	133
160	201011160	147,6	187,0	6,2	6	6145	145
200	201011200	184,6	228,8	7,7	6	6156	156
225	201011225	207,8	255,7	8,6	6	6162	162
250	201011250	230,8	284,0	9,6	6	6172	172
280	201011280	258,0	337,0	10,7	6	6175	175
315	201011315	290,8	352,9	12,1	6	6201	201
400	201011400	369,4	444,8	15,3	6	6212	212
630*	201011630	581,8	-	24,1	10	-	-

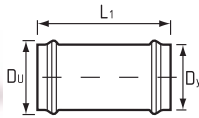

Z
Z :
:

Dy,		Du	() L1	M ()
	PN 10			
50	201051050	74,7	250	0,291
63	201051063	89,3	265	0,322
75	201051075	105,6	280	0,480
90	201051090	122,0	300	0,640
110	201051110	148,5	325	1,132
160	201051160	206,5	375	2,511
200	201051200	253,1	425	4,519
225	201051225	279,3	460	5,375
250	201051250	311,4	490	7,779
280	201051280	349,0	505	10,613
315	201051315	391,8	535	14,489
400	201051400	490,0	605	26,113
500*	201051500	—	360	—
630*	201051630	—	446	—
*			PN 6	

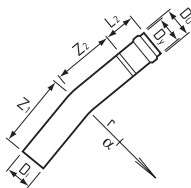

11°
Z
Z :
:

Dy,		Di	() Du	L2	r	Z1	Z2	M ()
	PN 10							
50	201060050	44,2	66	107	120	214	127	0,273
63	201060063	56,0	81	113	150	241	129	0,477
75	201060075	66,6	99	119	200	246	164	0,749
90	201060090	80,0	118	125	250	296	154	1,140
110	201060110	97,8	142	135	300	341	209	1,980
160	201060160	142,6	201	158	700	448	282	5,170
200	201060200	178,4	248	177	700	543	327	9,393
225	201060225	200,8	277	183	900	524	377	12,324
250	201060250	223,4	306	195	1000	704	386	17,807
280	201060280	250,0	342	199	1200	800	431	24,947
315	201060315	281,6	384	209	1300	941	450	34,746
400	201060400	357,4	488	234	2000	1369	523	74,160
500*	201060500	467,4	610	308	2500	1691	581	89,203
*								PN 6

()

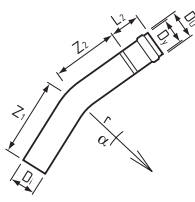

22°

Z « »
Z :
:

Dy,		Di	Di () Du	L2	r	Z1	Z2	M ()
	PN 10							
50	201061050	44,2	66	107	120	212	138	0,321
63	201061063	56,0	81	113	150	227	144	0,563
75	201061075	66,6	99	119	200	277	184	0,934
90	201061090	80,0	118	125	250	323	179	1,379
110	201061110	97,8	142	135	300	363	238	2,376
160	201061160	142,6	201	158	700	482	351	7,102
200	201061200	178,4	248	177	700	577	396	12,397
225	201061225	200,8	277	183	900	589	465	18,286
250	201061250	223,4	306	195	1000	760	484	24,488
280	201061280	250,0	342	199	1200	837	548	34,152
315	201061315	281,6	384	209	1300	1119	578	51,566
400	201061400	357,4	488	234	2000	1531	719	113,266
500*	201061500	467,4	610	308	2500	1956	826	125,693
*			PN 6					

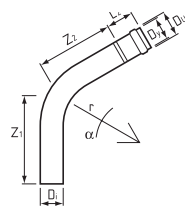

30°

Z « »
Z :
:

Dy,		Di	Di () Du	L2	r	Z1	Z2	M ()
	PN 10							
50	201062050	44,2	66	107	120	244	147	0,321
63	201062063	56,0	81	113	150	267	155	0,563
75	201062075	66,6	99	119	200	314	199	0,934
90	201062090	80,0	118	125	250	356	197	1,379
110	201062110	97,8	142	135	300	393	260	2,376
160	201062160	142,6	201	158	700	536	403	7,102
200	201062200	178,4	248	177	700	630	448	12,397
225	201062225	200,8	277	183	900	730	531	18,286
250	201062250	223,4	306	195	1000	844	558	24,488
280	201062280	250,0	342	199	1200	908	637	34,152
315	201062315	281,6	384	209	1300	1293	673	51,566
400	201062400	357,4	488	234	2000	1699	866	113,266
500*	201062500	467,4	610	308	2500	1891	1010	125,693
*			PN 6					

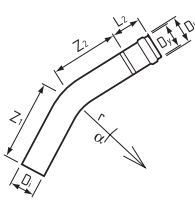

45°

Z « »
Z :
:

Dy,		Di	Di () Du	L2	r	Z1	Z2	M ()
	PN 10							
50	201063050	44,2	66	107	120	280	165	0,321
63	201063063	56,0	81	113	150	299	177	0,563

()

Dy,		Di	() Du L2		r	Z1	Z2	M ()
	PN 10							
75	201063075	66,6	99	119	200	341	228	0,934
90	201063090	80,0	118	125	250	377	234	1,379
110	201063110	97,8	142	135	300	409	304	2,376
160	201063160	142,6	201	158	700	605	505	7,102
200	201063200	178,4	248	177	700	700	550	12,397
225	201063225	200,8	277	183	900	826	663	18,286
250	201063250	223,4	306	195	1000	929	704	24,488
280	201063280	250,0	342	199	1200	1020	812	34,152
315	201063315	281,6	384	209	1300	1382	863	51,566
400	201063400	357,4	488	234	2000	1968	1158	113,266
500*	201063500	467,4	610	308	2500	2102	1376	125,693
*		PN 6						

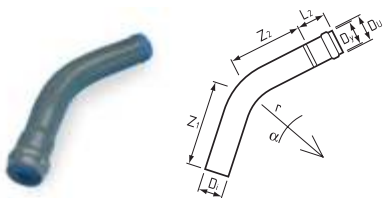

60°

Z « »
Z :
:

Dy,		Di	() Du L2		r	Z1	Z2	M ()
	PN 10							
50	201064050	44,2	66	107	120	289	184	0,349
63	201064063	56,0	81	113	150	335	202	0,649
75	201064075	66,6	99	119	200	371	260	1,118
90	201064090	80,0	118	125	250	453	274	1,731
110	201064110	97,8	142	135	300	479	353	3,035
160	201064160	142,6	201	158	700	736	619	10,137
200	201064200	178,4	248	177	700	831	664	17,118
225	201064225	200,8	277	183	900	937	810	25,333
250	201064250	223,4	306	195	1000	1130	867	34,510
280	201064280	250,0	342	199	1200	1101	1008	48,378
315	201064315	281,6	384	209	1300	1804	1076	72,590
400	201064400	357,4	488	234	2000	2270	1485	145,571

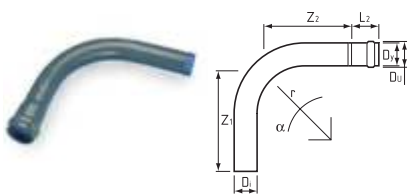

90°

Z « »
Z :
:

Dy,		Di	() Du L2		r	Z1	Z2	M ()
	PN 10							
50	201065050	44,2	66	107	120	307	235	0,349
63	201065063	56,0	81	113	150	369	265	0,649
75	201065075	66,6	99	119	200	451	345	1,118
90	201065090	80,0	118	125	250	527	380	1,731
110	201065110	97,8	142	135	300	599	480	3,035
160	201065160	142,6	201	158	700	1015	915	10,137
200	201065200	178,4	248	177	700	1110	960	17,118
225	201065225	200,8	277	183	900	1296	1190	25,333
250	201065250	223,4	306	195	1000	1479	1290	34,510
280	201065280	250,0	342	199	1200	1630	1515	48,378
315	201065315	281,6	384	209	1300	2123	1625	72,590
400	201065400	357,4	488	234	2000	2518	2330	145,571

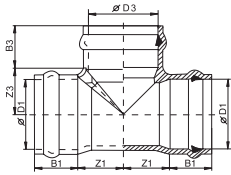

Z « »

Z :

:

D1,		D3	() B1	Z1	B3	Z3
PN 12,5						
63 ? 63 ? 63	366 531 400		96	41		
75 ? 63 ? 75	366 531 810	63	102	48	96	48
75 ? 75 ? 75	366 531 800		102	48		
90 ? 63 ? 90	366 532 220	63	108	50	96	54
90 ? 75 ? 90	366 532 210	75	108	50	102	56
90 ? 90 ? 90	366 532 200		108	57		
110 ? 63 ? 110	366 532 430	63	115	53	96	72
110 ? 75 ? 110	366 532 420	75	115	53	102	66
110 ? 90 ? 110	366 532 410	90	115	61	108	67
110 ? 110 ? 110	366 532 400		115	69		
160 ? 90 ? 160	366 532 440	90	131	67	108	92
160 ? 110 ? 160	366 533 430	110	131	76	115	95
160 ? 160 ? 160	366 533 400		131	100		
PN 10						
200 ? 110 ? 200	366 533 850	110	140	123	115	115
200 ? 160 ? 200	366 533 820	160	140	123	131	117
200 ? 200 ? 200	366 533 800		140	123		
225 ? 90 ? 225	366 534 040	90	150	75	108	132
225 ? 110 ? 225	366 534 050	110	150	75	115	135
225 ? 160 ? 225	366 534 020	160	150	140	131	139
225 ? 225 ? 225	366 534 000		150	140		
250 ? 250 ? 250	366 534 200		168	166		
315 ? 315 ? 315	366 534 600		192	210		

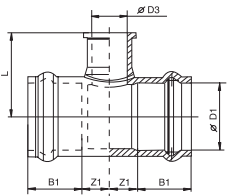

Z ?

Z « »

Z :

:

D1,		D3	() B1	Z1	L
PN 12,5					
63 ? 63 ? 63	366 561 400	63	41	96	137
75 ? 63 ? 75	366 561 810	63	48	102	144
75 ? 75 ? 75	366 561 800	75	48	102	150
90 ? 63 ? 90	366 562 220	63	108	50	150
90 ? 75 ? 90	366 562 210	75	108	50	158
90 ? 90 ? 90	366 562 200	90	108	57	165
110 ? 63 ? 110	366 562 430	63	115	53	168
110 ? 75 ? 110	366 562 420	75	115	53	168
110 ? 90 ? 110	366 562 410	90	115	61	175
110 ? 110 ? 110	366 562 400	110	115	69	184
160 ? 90 ? 160	366 563 440	90	131	67	200
160 ? 110 ? 160	366 563 430	110	131	76	210
160 ? 160 ? 160	366 563 400	160	131	100	231
PN 10					
200 ? 90 ? 200	366 563 860	90			
200 ? 110 ? 200	366 563 850	110			
200 ? 160 ? 200	366 563 820	160			
225 ? 90 ? 225	366 564 060	90	150	75	240
225 ? 110 ? 225	366 564 050	110	150	75	250
225 ? 160 ? 225	366 564 020	160	150	140	270

()

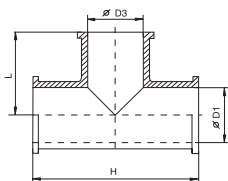

Z : « »

D1,		D3	(H)	L
90?0?0	366 522 200	90	330	165
110?0?10	366 522 410		344	175
110?10?10	366 522 400		364	182
160?0?60	366 523 440	90	402	202
160?10?60	366 523 430	110	410	211
160?60?60	366 523 400		460	231

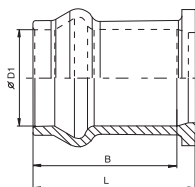

Z : « »

Z : « »

D1,		B	(L)
63	366 581 400	96	108
75	366 581 800	102	115
90	366 582 200	108	123
110	366 582 400	115	134
160	366 583 400	131	155

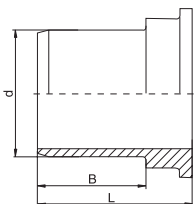

Z : « »

d,		B	(L)
63 DN50	366 571 400	97,5	142
75 DN65	366 571 800	101	154
90 DN80	366 572 200	108	162
110 DN100	366 572 400	115	170
160 DN150	366 573 400	137	196

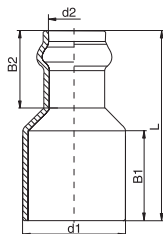

Z : « »

Z : « »

d1?2,		B1	(B2)	L
	PN 12,5			
75?3	366 541 810	111	41	232
90?3	366 542 220	116	108	243
110?3	366 542 430	125	115	257
110?0	366 552 410	122	115	270
160?3	366 553 420	140	115	302
160?10	366 543 430	143	131	314

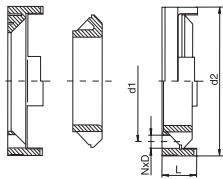

Z : ()

d1,		d2	()	L	NxD
63	361033070	165	35	4 x 18	
75	361033080	185	45	4 x 18	
90	361033090	200	42	8 x 18	
110	361033110	220	43	8 x 18	
160	361033160	285	40	8 x 21	

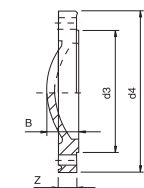

TYPE A



TYPE B



Z : ()

D,		d2	()	d3	d4	Z	B	NxD
75	361034110	139.5/144	106	185	19	26,5	4x19	
90	361034090	152.5/159	125	200	20	30,0	8x19	
110	361034110	181/190.5	150	220	22	34.5	8x19	
160	361034160	240	209	285	28	43.5	8x24	

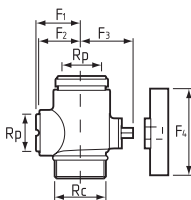

Z : 11/2"

Rp/Rc		F1	()	F2	F3	F4	H	M ()
11/2" / 11/2"	PN 10 201081100	-	66,5	47,5	110	110	0,463	

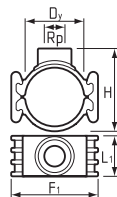

Z : 11/2"

Dy,	/Rp		F1	()	H	L1	M ()
63	11/2"	PN 10 201081110	92,6	105,2	76	0,4	
75	11/2"	201081120	99,0	117,2	76	0,4	
90	11/2"	201081130	114,0	132,2	76	0,4	
110	11/2"	201081140	137,0	152,2	80	0,6	
160	11/2"	201081150	228,0	202,0	90	0,8	

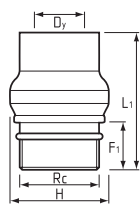

z 11/2"

z :

:

Dy, /R		F1	() H	L1	M ()
	PN 10				
25 11/2"	201086001	29	58	80	0,1
32 11/2"	201086002	29	64	91	0,2
40 11/2"	201086003	29	78	115	0,2

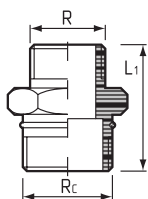

z 11/2"

z :

:

Rc/R		L1	() M ()
	PN 10		
11/2" 1"	281081190	60	0,5
11/2" 11/4"	281081200	60	0,5
11/2" 11/2"	281081210	60	0,5

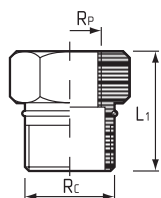

z 11/2"

z :

:

Rc/Rp		L1	M
	PN 10		
11/2" 1"	281081220	48	0,5
11/2" 11/4"	281081230	48	0,5

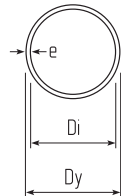
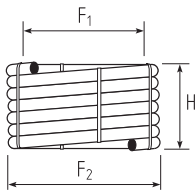

z
z :

Dy,	Di	e	F1	F2	H	M
80,						
PN 6,3, SDR 17						
32	221130103	27,4	2,3	1150	1500	0,2
32	221130303	27,4	2,3	1150	1500	0,2
32	221130603	27,4	2,3	1150	1500	0,2
40	221130104	35,4	2,3	1250	1750	0,3
40	221130304	35,4	2,3	1250	1750	0,3
40	221130604	35,4	2,3	1250	1750	0,3
50	221130305	44,2	2,9	1650	2100	0,5
63	221130307	55,8	3,6	1650	2150	0,7
75	221130308	66,4	4,3	1925	2750	1
90	221130109	79,8	5,1	2300	2650	1,4
80,						
PN 10, SDR 11						
25	221100102	20,4	2,3	1150	1500	0,2
25	221100302	20,4	2,3	1150	1500	0,2
25	221100602	20,4	2,3	1150	1500	0,2
32	221100103	26,2	2,9	1150	1500	0,3
32	221100303	26,2	2,9	1150	1500	0,3
32	221100603	26,2	2,9	1150	1500	0,3
40	221100104	32,6	3,7	1250	1750	0,4
40	221100304	32,6	3,7	1250	1750	0,4
40	221100604	32,6	3,7	1250	1750	0,4
50	221100105	40,8	4,6	1650	2100	0,7
63	221100307	51,4	5,8	1650	2150	1
75	221110108	61,4	6,8	1925	2750	1,5
90	221100109	73,6	8,2	2300	2650	2,1
100,						
PN 10, SDR 17						
40	221220340	35,2	2,4	-	-	0,3
50	221220350	44,0	3,0	-	-	0,45
63	221220163	55,4	3,8	-	-	0,7
63	221220363	55,4	3,8	-	-	0,7
75	221220175	66,0	4,5	-	-	1
110	221220309	96,8	6,6	-	-	1,4

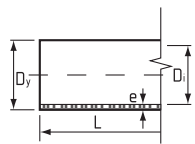

z
z :

Dy,	Di	e	L	M
80,				
PN 6,3, SDR 17				
90	221131509	79,8	5,1	1,4
110	221131511	97,4	6,3	2,1
80,				
PN 10, SDR 11				
90	221101509	73,6	8,2	2,1
110	221101511	90,0	10,0	3,1

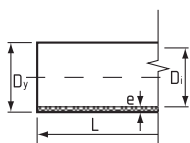

D _e		D _i	e	L ()	M (/)
	100,	PN 6,3, SDR 26			
90	221251509	83,0	3,5	12	0,9
110	221251511	101,6	4,2	12	1,4
125	221251513	115,4	4,8	12	1,9
140	221251514	129,2	5,4	12	2,3
160	221251516	147,6	6,2	12	3,1
180	221251518	166,2	6,9	12	3,8
200	221251520	184,6	7,7	12	4,7
225	221251523	207,8	8,6	12	5,9
250	221251525	230,8	9,6	12	7,3
280	221251528	258,6	10,7	12	9,2
315	221251532	290,8	12,1	12	11,7
355	221251536	327,8	13,6	12	14,7
400	221251540	369,4	15,3	12	19,0
500	221251550				
630	221251563				
	100,	PN 10, SDR 17			
90	221221509	79,2	5,4	12	1,4
110	221221511	96,8	6,6	12	2,2
125	221221513	110,2	7,4	12	2,8
140	221221514	123,4	8,3	12	3,5
160	221221516	141,0	9,5	12	4,5
180	221221518	158,6	10,7	12	5,7
200	221221520	176,2	11,9	12	7,1
225	221221523	198,2	13,4	12	9,0
250	221221525	220,4	14,8	12	11,0
280	221221528	246,8	16,6	12	13,8
315	221221532	277,6	18,7	12	17,5
355	221221536	312,8	21,1	12	22,3
400	221221540	352,6	23,7	12	28,8
500	221221550	440,6	29,7	12	43,8
450	221221545	396,6	26,7	12	35,4
560	221221556	493,6	33,2	12	54,8
630	221221563	555,2	37,4	12	69,4
	100,	PN 16, SDR 11			
90	221201509	73,6	8,2	12	2,1
110	221201511	90,0	10,0	12	3,2
125	221201513	102,2	11,4	12	4,1
140	221201514	114,6	12,7	12	5,1
160	221201516	130,8	14,6	12	6,7
180	221201518	147,2	16,4	12	8,5
200	221201520	163,6	18,2	12	10,4
225	221201523	184,0	20,5	12	13,2
250	221201525	204,6	22,7	12	16,3
280	221201528	229,2	25,4	12	20,4
315	221201532	257,8	28,6	12	25,8
355	221201536	290,4	32,3	12	32,8
400	221201540	327,2	36,4	12	42,5
500	221201650	409,2	45,4	12	64,5
450	221201645	368,2	40,9	12	47,8
560	221201656	458,4	50,8	12	87,5
630	221201663	515,6	57,2	12	102,4

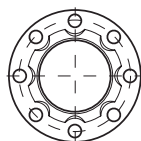

« / »

Z , ,

Z :

PN 16

60+63+66/50	281840705
75+76+82/65	281840105
89+90+98/80	281840905
108+110+118/100	281841105
140+144/125	281841405
125+133/125	281841305
160+168+170/150	281841605
200+219/200*	281842004
222+225/200*	281842304
274+280/250*	281842504
250+273/250*	281842804
326/300*	281843204
315+324/300*	281843205
429/400*	281844304
400/400*	281844004
532/500*	281845304
500/500*	281845004
600	281846004

*

PN 10

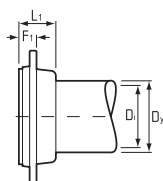

« / »

Z ,

Z :

Dy/DN,

F1 () L1 M ()

Dy/DN,	PN 16	F1	() L1	M ()
63/50	281840762	25	48	2,4
75/65	281840862	25	50	2,1
90/80	281840962	28	54	2,7
110/100	281841162	29	58	3,2
125/125	281841362	31	66	5,7
140/125	281841462	31	66	5,7
160/150	281841662	33	73	5,7
200/200*	281842062	40	87	10,3
225/200*	281842362	40	87	9,4
250/250*	281842562	48	101	16,0
280/250*	281842862	48	101	15,9
315/300*	281843262	50	105	22,8
400/400*	281844062	63	133	37,8
500/500*	281845062	80	158	59,4
630/600	281846062	-	-	-

*

PN 10

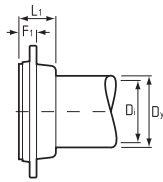

« / »

Z .

Z :

Dy/DN,

F1

()

L1

M ()

PN 16

63/50	281840767	25	48	2,6
75/65	281840867	25	50	2,4
90/80	281840967	28	54	3,1
110/100	281841167	29	58	3,7
125/125	281841367	31	66	6,3
140/125	281841467	—	—	—
160/150	281841667	33	73	6,6
200/200*	281842067	40	87	12,4
225/200*	281842367	40	87	12,0
250/250*	281842567	48	101	20,3
280/250*	281842867	48	101	17,7
315/300*	281843267	50	105	25,6

PN 10

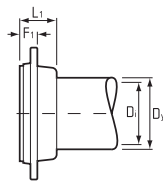

« / »

Z .

Z :

Dy/DN,

F1

()

L1

M ()

PN 16

63/50	281840747	25	48	2,6
75/65	281840847	25	50	2,4
90/80	281840947	28	54	3,1
110/100	281841147	29	58	3,7
125/125	281841347	31	66	6,3
140/125	281841447	—	—	—
160/150	281841647	33	73	6,6
200/200*	281842047	40	87	12,4
225/200*	281842347	40	87	12,0
250/250*	281842547	48	101	20,3
280/250*	281842847	48	101	17,7
315/300*	281843247	50	105	25,6

PN 10

()

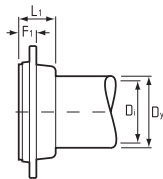

« / »

Z
Z :

Dy/DN,		F1	() L1	M ()
	PN 16			
66/50	281840722	25	48	2,4
86/65	281840857	25	50	2,0
98/80	281841022	–	–	–
108/100	281841152	–	–	–
118/100	281841222	29	58	3,0
144/125	281841522	–	–	–
170/150	281841722	33	73	5,3
222/200*	281842322	40	87	9,2
274/250*	281842822	48	101	15,2
	PN 16			
326/300*	281843322	50	105	22,5
428/400*	281844322	63	133	34,1
532/500*	281845422	80	158	56,0
			PN 10	

« / »

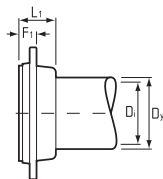

Z
Z :

Dy/DN,		F1	() L1	M ()
	PN 16			
82/65	281840927	25	50	2,2
90/80	281841028	–	–	–
98/80	281841028	28	54	2,8
118/100	281841226	29	58	3,5
144/100	281841427	–	–	–
170/150	281841627	33	73	6,1
222/200*	281842328	40	87	9,9
274/250*	281842827	48	101	17,9
326/300*	281843327	50	105	24,6
			PN 10	

« / »

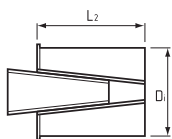

z
z :
:

Dy,		()		Di	L1
		80 PN	100 PN		
110	281841181	4	6,3	–	140
125	281841381	4	6,3	–	140
160	281841681	4	6,3	–	180
200	281842081	4	6,3	–	180
225	281842381	4	6,3	–	180
250	281842581	4	6,3	–	220
280	281842881	4	6,3	–	220
315	281843281	4	6,3	–	270
63	281840784	6,3	–	55,4	100
75	281840884	6,3	–	66,0	100
90	281840984	6,3	–	79,2	140
110	281841184	6,3	–	96,8	140
125	281841384	6,3	10	110,2	140
160	281841684	6,3	10	141,0	180
200	281842084	6,3	10	176,2	180
225	281842384	6,3	10	198,2	220
250	281842584	6,3	10	220,4	220
280	281842884	6,3	10	246,8	270
315	281843284	6,3	10	277,6	270
63	281840787	10	–	51,4	100
75	281840887	10	–	61,4	100
90	281840987	10	–	73,6	140
110	281841187	10	–	90,0	140
125	281841387	10	16	102,2	140
160	281841687	10	16	130,8	180
200	281842087	10	16	163,6	180
225	281842387	10	16	184,0	220
250	281842587	10	16	204,6	220
280	281842887	10	16	229,2	270
315	281843287	10	16	257,8	270

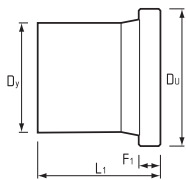

z
z :
:

Dy, /DN		()		L1
		Du	F1	
	PE 100,	PN 16, SDR 11		
20/15	222660010	45	7	89
25/20	222660020	58	9	86
32/25	222660030	68	10	80
40/32	222660040	78	11	85
50/40	222660050	88	12	92
63/50	222660070	102	14	100
75/65	222660080	122	16	120
90/80	222660090	138	17	140
110/100	222660110	158	18	160
125/100	222660130	158	25	170
140/125	222660140	188	25	191

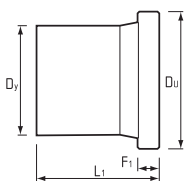

()

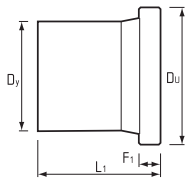

160/150	222660160	212	25	180
180/150	222660180	212	30	190
200/200	222660200	268	32	200
225/200	222660230	268	32	200
250/250	222660250	320	35	215
280/250	222660280	320	35	228
315/300	222660320	370	35	238
355/350	222660360	430	40	258
400/400	222660400	482	46	285

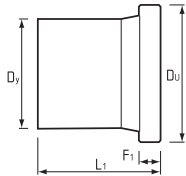

Z :
:

Dy, /DN () Du F1 L1

PE 100,		PN 10, SDR 17		
90/80	222662090	-	-	-
110/100	222662110	158	18	142
125/100	222662130	158	25	141
140/125	222662140	190	25	160
160/150	222662160	212	25	172
180/150	222662180	212	30	176
200/200	222662200	268	32	186
225/200	222662230	268	32	197
250/250	222662250	320	35	209
280/250*	222662280	320	35	110
315/300*	222662320	370	35	110
355/350*	222662360	430	40	130
400/400*	222662400	482	45	130

630

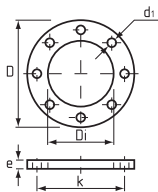

Z :
:

Dy, /DN () D d1 Di e k

PN 6,3, PN 10		PN 16					
32/25	281999203	115	14,5	38	17	85	4
40/32	281999204	140	17,5	46	17	100	4
50/40	281999205	150	18,5	56	17	110	4
63/50	281999206	165	18,0	78	16	125	4
75/65	281999208	185	18,0	92	16	145	4
90/80	281999209	200	18,0	108	18	160	8
110/100	281999211	220	18,0	128	18	180	8
125/100	281999213	220	18,0	135	18	180	8
160/150	281999216	285	22,0	178	18	240	8
180/150	281999218	285	22,0	188	18	240	8
200/200*	281999220	340	22,0	225	20	295	8
225/200*	281999223	340	22,0	238	20	295	8
250/250*	281999225	395	22,0	273	22	350	12
280/250*	281999228	395	22,0	294	26	350	12
315/300*	281999232	445	22,0	329	26	400	12
355/350*	281999236	505	22,0	376	28	460	16
400/400*	281999240	565	26,0	430	32	515	16

PN 16.

PN 16

630

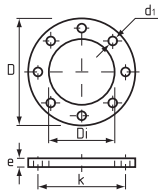

z : ()

Dy, /DN		D	() d1	Di	e	k	()
	PN 6,3 PN 10						
25/20	291999200	105	14	34	17	75	4 0,1
32/25	291999201	116	14	42	16	85	4 0,424
40/32	291999202	141	18	51	16	100	4 0,663
50/40	291999203	151	18	62	18	110	4 0,689
63/50	291999206	166	18	78	18	125	4 0,791
75/65	291999208	187	18	92	18	145	4 1,152
90/80	291999209	202	18	108	18	160	8 1,240
110/100	291999211	222	18	128	18	180	8 1,360
125/100	291999213	222	18	135	18	180	8 1,340
140/125	291999214	250	18	158	24	210	8 1,820
160/150	291999216	287	22	178	24	240	8 2,483
180/150	291999218	287	22	188	24	240	8 2,461
200/200	291999220	341	22	235	24	295	8 3,271
225/200	291999223	341	22	238	24	295	8 2,814
250/250	291999225	409	22	288	30	350	12 6,065
280/250	291999228	409	22	294	30	350	12 5,752
315/300	291999232	463	22	338	34	400	12 9,960
355/350	291999236	513	23	376	42	460	16 14,650
400/400	291999240	575	26	430	46	515	16 17,632

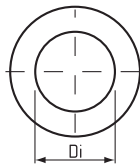

z : ()

DN		Di	()
	PN 10		
25	281999529	22	
32	281999530	28	
40	281999531	34	
50	281999532	42	
63	281999533	53	
75	281999534	63	
90	281999335	76	
110	281999336	93	
125	281999337	105	
140	281999544	–	
160	281999338	135	
180	281999339	–	
200	281999340	168	
225	281999341	188	
250	281999342	208	
280	281999343	233	
315	281999344	262	
355	281999545	–	
400	281999546	331	
450	281999547	372	
500	281999548	413	
560	281999549	462	
630	281999550	519	

()

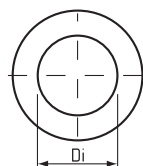

DN	PN 16	Di ()
25	281999327	24
32	281999329	30
40	281999330	37
50	281999331	46
63	281999333	58
75	281999334	69
90	281999309	84
110	281999311	100
125	281999313	114
140	281999314	127
160	281999316	146
180	281999318	164
200	281999320	181
225	281999323	203
250	281999325	226
280	281999328	252
315	281999332	283
355	281999436	319
400	281999440	359
450	281999345	403
500	281999350	447
560	281999356	494
630	281999363	555

630

* PN16

15°

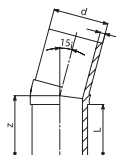

Dy	z	Z ()
63	100, 222610007	PN 16, SDR 11 70
75	222610008	75
90	222610009	85
110	222610011	90
125	222610013	95
160	222610016	110
180	222610018	120
200	222610020	125
225	222610023	130
90	100, 222610309	PN 10, SDR 17 85
110	222610311	90
125	222610313	95
160	222610316	110
180	222610318	120
200	222610320	125
225	222610323	130

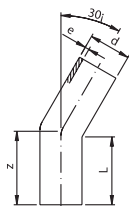

30°

		Z				
		:				
		:				
Dy		Z	L	() e	i	m ()
100,		PN 16, SDR 11				
63*	222612007	88	65	5.8	0.207	15
75*	222612008	95	70	6.9	0.250	15
90	222612009	208	193	8.2	0.540	10
110	222612011	216	197	10.0	0.840	2
125*	222612013	125	90	11.4	1.030	2
160	222612016	231	205	14.6	2.050	2
180*	222612018	150	107	16.4	2.907	5
200*	222612020	160	117	18.2	3.820	2
225*	222612023	170	122	20.5	5.360	3
100,		PN 10, SDR 17				
90	222612209	208	193	5.4	0.430	2
110	222612211	216	197	6.6	0.620	5
125*	222612213	125	90	7.4	0.860	15
160	222612216	231	205	9.5	1.600	2
180*	222612218	150	107	10.7	2.040	3
200*	222612220	160	117	11.9	2.780	2
225*	222612223	170	122	13.4	3.880	2

*

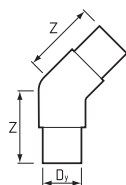

45°

		Z				
		:				
		:				
Dy		Z			()	
100,		PN 6,3, SDR 26				
110	221252312	130				
125	221252314	140				
160	221252317	160				
180	221252319	170				
200	221252321	185				
225	221252324	200				
100,		PN 10, SDR 17				
90	222613209	120				
110	222613211	130				
125	222613213	140				
140	222613214	164				
160	222613216	162				
180	222613218	170				
200	222613220	185				
225	222613223	200				
250	222613225	220				
280	222613228	230				
315	222613232	250				

()

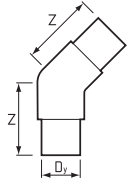

100, PN 16, SDR 11

20	222613001	70
25	222613002	75
32	222613003	80
40	222613004	85
50	222613005	90
63	222613007	95
75	222613008	105
90	222613009	120
110	222613011	130
125	222613013	140
140	222613014	135
160	222613016	160
180	222613018	170
200	222613020	185
225	222613023	200
250	222613025	220
280	222613028	230
315	222613032	250

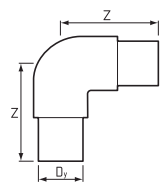

90°

z :
:
Dy, z ()

100, PN 6,3, SDR 26

110	221252512	165
125	221252514	180
160	221252517	210
180	221252519	230
200	221252521	250
225	221252524	270

Dy, z ()

100, PN 10, SDR 17

90	222616209	150
110	222616211	165
125	222616213	180
140	222616214	202
160	222616216	210
180	222616218	230
200	222616220	250
225	222616223	270
250	222616225	292
280	222616228	320
315	222616232	370

()

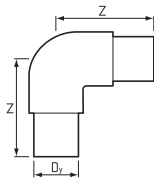

	100,	PN 16, SDR 11
20	222616002	75
25	222616003	80
32	222616004	85
40	222616005	95
50	222616006	105
63	222616007	115
75	222616008	130
90	222616009	150
110	222616011	165
125	222616013	180
140	222616014	202
160	222616016	210
180	222616018	232
200	222616020	253
225	222616023	270
250	222616025	292
280	222616028	320
315	222616032	370

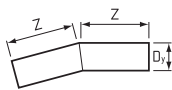

	100,	PN 6,3, SDR 26
110	221252011	308
125	221252013	309
140	221252014	309
160	221252016	511
180	221252018	512
200	221252020	514
225	221252023	515
250	221252025	517
280	221252028	519
315	221252032	521
355	221252036	524
400	221252040	527

	100,	PN 10, SDR 17
110	221222011	308
125	221222013	309
140	221222014	309
160	221222016	511
180	221222018	512
200	221222020	514

()

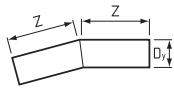

Dy,

Z

()

Dy,	100,	PN 10, SDR 17
225	221222023	515
250	221222025	517
280	221222028	519
315	221222032	521
355	221222036	524
400	221222040	527
		630

30°

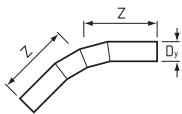

Z

Z

()

Dy,

Dy,	100,	PN 6,3
110	221252211	393
125	221252213	395
140	221252214	397
160	221252216	626
180	221252218	628
200	221252220	631
225	221252223	686
250	221252225	689
280	221252228	693
315	221252232	698
355	221252236	703
400	221252240	709

Dy,	100,	PN 10
110	221222211	393
125	221222213	395
140	221222214	397
160	221222216	626
180	221222218	628
200	221222220	631
225	221222223	686
250	221222225	689
280	221222228	693
315	221222232	698
355	221222236	703
400	221222240	709
		630

45°

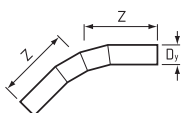

Z

Z

()

Dy,

Dy,	100,	PN 6,3
110	221252511	484
125	221252513	487
140	221252515	490
160	221252516	748
180	221252518	753
200	221252520	757
225	221252523	869
250	221252525	874

()

45°

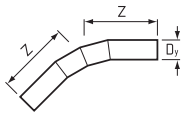

Z :
:

Dy, Z ()

Dy	100,	PN 6,3
280	221252528	880
315	221252532	887
355	221252536	895
400	221252540	904

Dy	100,	PN 10
110	221222311	484
125	221222313	487
140	221222314	490
160	221222316	748
180	221222318	753
200	221222320	757
225	221222323	869
250	221222325	874
280	221222328	880
315	221222332	887
355	221222336	895
400	221222340	904
560	221222556	— 630

60°

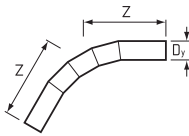

Z :
:

Dy, Z ()

Dy	100,	PN 6,3, SDR 26
110	221252411	586
125	221252413	590
140	221252415	595
160	221252416	885
180	221252418	891
200	221252420	897
225	221252423	1073
250	221252425	1079
280	221252428	1089
315	221252432	1098
355	221252436	1109
400	221252440	1122

Dy	100,	PN 10, SDR 17
110	221222411	586
125	221222413	590
140	221222414	595
160	221222416	885
180	221222418	891
200	221222420	897
225	221222423	1073
250	221222425	1079
280	221222428	1089
315	221222432	1098
355	221222436	1109
400	221222440	1122 630

()

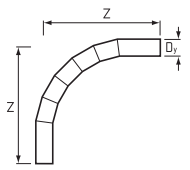

90°

Z :
Dy, Z ()

	100,	PN 6,3, SDR 26
110	221252511	850
125	221252513	858
140	221252514	865
160	221252516	1240
180	221252518	1250
200	221252520	1261
225	221252523	1602
250	221252525	1614
280	221252528	1629
315	221252532	1647
355	221252536	1667
400	221252540	1689

	100,	PN 10, SDR 17
110	221222511	850
125	221222513	858
140	221222514	865
160	221222516	1240
180	221222518	1250
200	221222520	1261
225	221222523	1602
250	221222525	1614
280	221222528	1629
315	221222532	1647
355	221222536	1667
400	221222540	1689
630	221222563	630

()

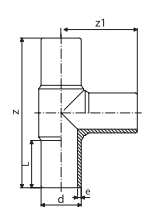

90°

Z :
d, z () z1 L

	100,	PN 16, SDR 11		
20	222620602	150	75	52
25	222620603	160	80	52
32	222620604	170	85	54
40	222620605	190	95	57
50	222620606	210	105	63
63	222620607	230	115	65
75	222620608	264	132	72
90	222620609	300	150	81
110	222620611	330	165	86
125	222620613	366	183	92
140	222620614	396	196	100
160	222620616	420	210	102
180	222620618	460	230	107
200	222620620	500	250	117
225	222620623	540	270	122

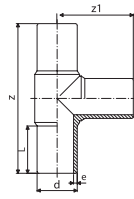

d,	z	() z1	L
	100,	PN 16, SDR 11	
250	222620625	575	288
280	222620628	615	308
315	222620632	695	346
355	222620636	818	408
400	222620640	910	455
450	222620645	970	485
500	222620650	1060	530

90°

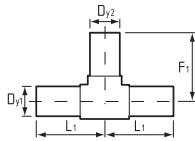

Dy1/Dy2,	F1	() L1
----------	----	-----------

*

,

100,

PN 6,3, SDR 26

110/110*	221253011	295	295
125/125*	221253013	180	180
140/140**	221253014	380	380
160/160*	221253016	210	210
180/180*	221253018	230	230
200/200*	221253020	250	250
225/225*	221253023	270	270
250/250**	221253025	325	325
280/280**	221253028	410	410
315/315**	221253032	392	392
355/355**	221253036	622	622
400/400**	221253040	680	680

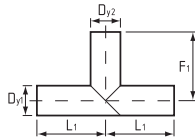

100,

PN 10, SDR 17

90/90	222622609	300	150
110/110*	222622611	165	165
125/125*	222622613	180	180
140/140**	222622614	380	380
160/160*	222622616	210	210
180/180*	222622618	230	230
200/200*	222622620	250	250
225/225*	222622623	270	270
250/250**	222622625	325	325
280/280**	222622628	410	410
315/315**	222622632	392	392
355/355**	222622636	622	622
400/400**	222622640	680	680
450/450	222622645	970	485
500/500	222622650	1060	530

*
**

630

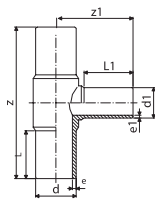

90°

Z :
:

d/d1, z () z1

d/d1,	z	()	z1
	100,	PN 16, SDR 11	
40/20*	222630587	190	120
40/25*	222630588	190	120
50/20*	222630589	210	140
50/25*	222630590	210	130
50/32*	222630591	210	130
63/32*	222630592	230	145
63/40*	222630593	230	145
63/50	222630594	215	103
75/32	222630595	256	108
75/50	222630596	255	108
75/63	222630597	255	117
90/50	222630598	272	117
90/63	222630599	269	136
90/75	222630600	272	138
110/63	222630601	320	147
110/75	222630602	309	151
110/90	222630603	310	152
125/75*	222630604	183	225
125/90	222630605	335	170
125/110	222630606	340.5	169.5
160/63	222630607	340	175.5
160/75	222630608	340	179.5
160/90	222630609	340	179.5
160/110	222630610	412	195
160/125*	222630611	420	265
180/90	222630612	420	202
180/110	222630613	430	205
180/125*	222630614	460	285
180/160	222630615	411	204.5
200/63	222630616	500	250
200/90	222630617	500	250
200/110	222630618	500	250
200/125*	222630619	500	295
200/160	222630620	500	250
225/75	222630621	441	226.5
225/90	222630622	558	276
225/110	222630623	558	276
225/125*	222630624	540	320
225/160	222630625	560	276
225/180	222630626	543	276.5
315/225	222630631	650	335
315/250	222630632	695	325

*

()

90°

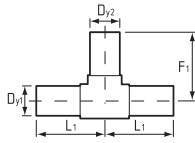

Z :

Dy1/Dy2,

F1

()
L1

*

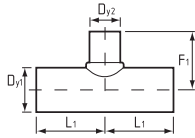

100,		PN 6,3, SDR 26	
110/63/110*	221253305	255	165
110/90/110*	221253307	280	165
160/32/160	221253319	—	—
160/40/160	221253320	—	—
160/50/160	221253321	—	—
160/63/160	221253322	177	340
160/75/160	221253323	195	340
160/90/160	221253324	195	340
160/110/160	221253325	233	340
180/32/180	221253330	—	—
180/40/180	221253331	—	—
180/50/180	221253332	—	—
180/63/180	221253333	187	340
180/90/180	221253334	205	340
180/110/180	221253335	243	340
200/32/200	221253355	—	—
200/40/200	221253356	—	—
200/50/200	221253357	—	—
200/63/200	221253358	197	340
200/90/200	221253359	210	340
200/110/200	221253365	253	340
200/160/200	221253360	301	340
225/32/225	221253375	—	—
225/40/225	221253376	—	—
225/50/225	221253377	—	—
225/63/225	221223395	219	340
225/90/225	221253370	237	340
225/110/225	221223385	230	340
225/160/225	221223380	303	340
250/40/250	221253391	—	—
250/63/250	221253392	222	340
250/90/250	221253393	240	340
250/110/250	221223405	269	340
250/160/250	221223400	308	340
315/40/315	221253417	—	—
315/63/315	221223435	255	340
315/90/315	221253419	262	340
315/110/315	221223425	269	340
315/160/315	221223420	308	340

630

()

90°

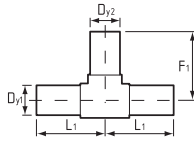

Z

:

:

Dy1/Dy2,

F1

()
L1

*

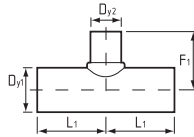

Dy1/Dy2,	100,	PN 10, SDR 17	() L1
90/50/90	222632598	272	117
90/63/90	222632599	269	135
90/75/90	222632600	274	137
110/63/110*	222632601	255	165
110/75/110	222632602	310	1552
110/90/110*	222632603	235	165
125/75/125	222632604	-	-
125/90/125	222632605	-	-
125/110/125	222632606	-	-
160/32/160	221253319	-	-
160/40/160	221253320	-	-
160/50/160	221253321	-	-
160/63/160	222632607	177	340
160/75/160	222632608	195	340
160/90/160	222632609	195	340
160/110/160	222632610	233	340
160/125/160	222632611	-	-
180/32/180	221223320	-	-
180/40/180	221223331	-	-
180/50/180	221223332	-	-
180/63/180	221253333	187	340
180/90/180	222632612	205	340
180/125/180	222632613	-	-
180/110/180	221253335	243	340
180/160/180	222632614	412	206.5
200/32/200	221223355	-	-
200/40/200	221223356	-	-
200/50/200	221223357	-	-
200/63/200	222632615	197	340
200/90/200	222632616	210	340
200/110/200	222632617	263	340
200/125/200	222632618	-	-
200/160/200	222632619	301	340
225/32/225	221223375	-	-
225/40/225	221223376	-	-
225/50/225	221223377	-	-
225/63/225	221223395	219	340
225/75/225	222632620	555	215
225/90/225	222632621	237	340
225/110/225	222632622	246	340
225/125/225	222632623	-	-
225/160/225	222632624	266	340
225/180/225	222632625	555	280
250/40/250	221253391	-	-
250/50/250	221223250	-	-
250/63/250	221253392	222	340
250/90/250	221253393	240	340
250/110/250	222632626	269	340
250/160/250	222632627	308	340
250/200/250	221223252	-	-
280/110/280	221223281	-	-
280/160/280	221223282	-	-
315/110/315	222632628	-	-
315/160/315	222632629	-	-
315/225/315	222632630	-	-
315/250/315	222362631	-	-

()

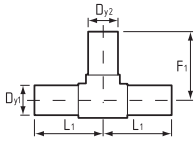

Dy1/Dy2,

F1 ()
L1

100,		PN 10, SDR 17	
315/40/315	221223417	—	—
315/63/315	221223435	255	340
315/90/315	221253419	262	340
315/110/315	221223425	307	340
315/160/315	221223420	326	340
315/225/315	222632630	650	335
315/250/315	221223322	—	—
400/315/400	221223402	—	—
		630	

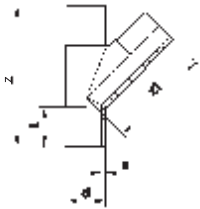
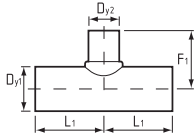

45°

z :

d, z () z1 L

100,		PN 16, SDR 11		
63	222622308	255	158	68
75	222622309	301	180	76
90	222622310	365	232	84
110	222622311	385	265	86
100,		PN 10, SDR 17		
90	222620310	365	232	84
110	222620311	385	265	86

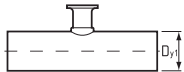

z :

Dy1,

110–1200

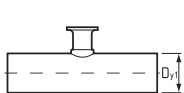

z :

Dy1/Dy2/Dy1,

160/225/160	221223161
200/225/200	221223201
225/225/225	221223231
250/225/250	221223251
280/225/280	221223281
315/225/315	221223321
400/225/400	221223401
450/225/450	221223451
500/225/500	221223501

110–1200

()

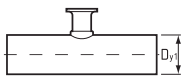

Z : :

Dy1/Dy2/Dy3,	110	160
200/225/200	221223202	221223203
225/225/225	221223232	221223233
250/225/250	221223254	221223255
280/225/280	221223292	221223291
315/225/315	221223426	221223421
400/225/400	221223407	221223409
450/225/450	221223452	221223453
500/225/500	221223504	221223505

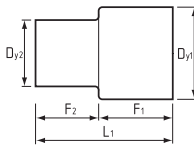

Z : :

Dy1/Dy2,	100,	F1	() F2	L1
		PN 6,3, SDR 26		
110/90	221254005	104	86	190
125/90	221254015	101	86	187
125/110	221254010	99	102	201
140/125	221254020	100	99	199
160/90	221254035	124	86	210
160/110	221254030	124	104	228
160/125	221243025	124	101	225
180/125	221254045	124	101	225
180/160	221254040	124	124	248
200/160	221254055	131	124	255
200/180	221254050	131	124	255
225/110	221254075	388	104	244
225/160	221254070	140	124	264
225/180	221254065	140	124	264
225/200	221254060	140	131	271
250/160	221254090	148	124	272
250/180	221254140	145	120	300
250/200	221254085	148	131	279
250/225	221254080	148	140	288
280/225*	221254100	70	40	130
280/250*	221254095	70	40	130
315/225*	221254115	90	40	150
315/250*	221254110	70	40	130
315/280*	221254105	70	40	130
355/280*	221254125	70	40	130
355/315*	221254120	70	40	130
400/315*	221254135	70	40	120
400/355*	221254130	70	40	110

63-225 ,

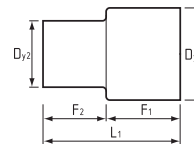

250-400 ,

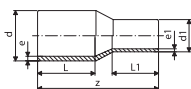

d/d1,		Z	() L	L1
	PE 100,	PN 10, SDR 17		
90/63	222642017	182	79	70
90/75	222642018	185	79	70
110/63	222642019	185	82	63
110/90	222642020	205	85	80
125/63	222642016	200	87	63
125/90	222642021	215	90	80
125/110	222642022	215	90	85
140/75	222642023	230	112	70
140/90	222642024	230	112	79
140/110	222642025	230	112	82
140/125	222642026	235	115	87
160/90	222642027	248	100	85
160/110	222642028	245	100	85
160/125	222642029	245	100	90
180/90	222642031	245	105	79
180/110	222642032	270	120	92
180/125	222642033	255	105	90
180/140	222642034	270	120	110
180/160	222642035	255	105	100
200/140	222642036	275	120	110
200/160	222642037	265	115	100
200/180	222642038	265	115	105
225/140	222642039	280	120	100
225/160	222642040	280	120	100
225/180	222642041	280	120	105
225/200	222642042	280	120	115
250/160	222642043	290	130	100
250/180	222642044	295	130	105
250/200	222642045	302	130	112
250/225	222642046	332	162	120
280/200	222642047	333	140	112
280/225*	222642048	335	140	120
280/250*	222642049	340	140	130
280/250	222642049	340	140	130
315/200	222642050	380	180	134
315/225*	222642051	365	150	120
315/250*	222642052	365	150	130
315/280*	222642053	365	150	140
355/250	222642054	390	165	130
355/280*	222642055	390	165	140
355/315*	222642056	390	165	150
400/280	222642057	415	180	139
400/315*	222642058	415	180	150
400/355*	222642059	420	180	165
450/280	222642067	389	195	140
450/315	222642060	390	195	150
450/355	222642061	393	195	164
450/400	222642062	395	195	179
500/315	222642063	422	212	150
500/355	222642064	424	212	164
500/400*	222642065	426	212	179
500/450	222642066	428	212	195
560/355	222642068	459	230	164
560/400	222642069	461	230	179
560/450	222642070	463	230	195
560/500*	222642071	466	230	212
630/400	222642072	502	250	179
630/450	222642073	503	250	195
630/500	222642074	506	250	212
630/560*	222642075	508	250	230

*

()

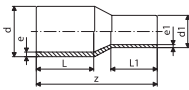

z

:

:

d/d1,

Z

()
L

L1

d/d1,		Z	() L	L1
	100,	PN 16, SDR 11		
25/20	222640001	120	54	52
32/20	222640002	120	54	52
32/25	222640003	130	57	52
40/20	222640004	130	57	52
40/25	222640005	130	57	52
40/32	222640006	130	57	53
50/20	222640007	150	63	52
50/25	222640008	140	63	52
50/32	222640009	140	63	53
50/40	222640010	140	63	57
63/32	222640011	150	65	53
63/40	222640012	150	65	57
63/50	222640013	150	65	63
75/40	222640014	170	72	57
75/50	222640015	170	72	63
75/63	222640016	170	72	65
90/50	222640017	190	81	63
90/63	222640018	190	81	65
90/75	222640019	190	81	70
110/63	222640020	205	86	65
110/75	222640021	205	86	70
110/90	222640022	205	86	81
125/63	222640023	187	87	61
125/75	222640024	215	92	72
125/90	222640025	215	92	81
125/110	222640026	215	92	86
140/75	222640057	230	112	70
140/90	222640058	230	112	79
140/110	222640059	230	112	82
140/125	222640060	211	96.5	90
160/90	222640027	217	102	74
160/110	222640028	245	102	86
160/125	222640061	245	102	92
160/140	222640062	229	101.5	96.5
180/ 90	222640063	245	105	79
180/110	222640064	255	107	92
180/125	222640065	270	120	92
180/140	222640066	270	120	110
180/160	222640067	255	107	102
200/140	222640029	275	120	110
200/160	222640032	265	117	102
200/180	222640030	275	120	110
225/140	222640031	295	130	110
225/160	222640034	280	112	102
225/180	222640035	290	128	120
225/200	222640036	280	122	117
250/160	222640037	290	130	100
250/180	222640038	295	130	105
250/200	222640039	302	130	112
250/225	222640040	332	162	120
280/200	222640041	333	140	112
280/225	222640042	335	140	120
280/250	222640043	340	140	130
315/200	222640044	380	180	134
315/225	222640050	365	150	120
315/250	222640096	365	150	130
315/280	222640051	365	150	139

()

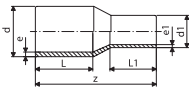

355/250	222640052	390	165	130
355/280	222640053	390	165	139
355/315	222640054	390	165	150
400/280	222640055	415	180	139
400/315	222640110	415	180	150
400/355	222640056	420	180	165

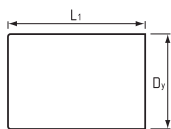

z : ()

Dy, L1 ()

20-315 ,

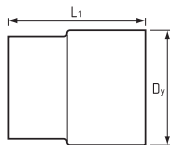

355-400 ,

Dy	L1	PN 6,3, SDR 26
110	100,	84
125	221255011	94
140	221255013	100
160	221255014	106
180	221255016	110
200	221255018	142
225	221255020	127
250	221255023	152
280*	221255025	162
315*	221255028	167
355*	221255032	297
400*	221255036	287
	221255040	
	100,	PN 10, SDR 17
90	222652009	90
110	222652011	94
125	222652013	100
140	222652015	106
160	222652016	110
180	222652018	142
200	222652020	127
225	222652023	142
250	222652025	152
280*	222652028	162
315*	222652032	167
355*	222652036	297
400*	222652040	287
	100,	PN 16, SDR 11
20	222650001	52
25	222650002	52
32	222650003	54
40	222650004	57
50	222650005	63
63	222650006	65
75	222650008	79
90	222650009	90
110	222650011	98
125	222650013	105
140	222650014	136
160	222650016	120
180	222650018	128
200	222650020	138

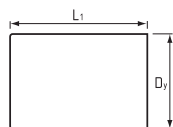

225	222650023	148
250	222650025	205
280	222650028	235
315	222650032	255
355	222650036	280
400	222650040	310
*		

20-315 ,

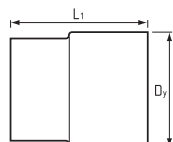

355-400 ,

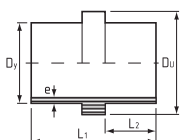

75-225 ,

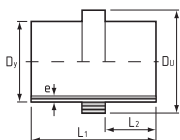

250-400 ,

z : :

Dy,	PE 100,	PN 6,3	() e	L1	L2
110	221256011	126	4,2	202	84
125	221256013	161	4,8	195	80
140	221256014	161	5,4	203	84
160	221256016	181	6,2	203	84
180	221256018	201	6,9	135	50
200	221256020	226	7,7	135	50
225	221256023	251	8,6	135	50
250	221256025	281	9,6	155	60
280	221256028	316	10,7	135	50
315	221256032	357	12,1	135	50
355	221256036	402	13,6	135	50
400	221256040	452	15,4	115	70
110	221226011	126	6,6	202	84
125	221226013	161	7,4	195	80
140	221226014	161	8,3	203	84
160	221226016	181	9,5	203	84
180	221226018	201	10,7	135	50
200	221226020	226	11,9	135	50
225	221226023	251	13,4	135	50
250	221226025	281	14,8	155	60
280	221226028	316	16,6	135	50
315	221226032	357	18,7	135	50
355	221226036	402	21,1	135	50
400	221226040	452	23,7	135	87
		630			

LU

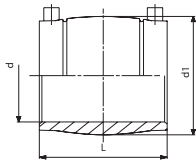

z
z
z
z

LU
PE 63, PE 80, PE 100, PE?a, WAVIN TS
:
39,5 V

d,		d1	() L
	100,	PN 16, SDR 11	
20*	222700001	33	55
25*	222700002	39	55
32*	222700003	46	60
40*	222700004	56	65
50	222700005	69	75
63	222700007	82	80
75	222700008	95	90
90	222700009	112	100
110	222700011	137	110

LU

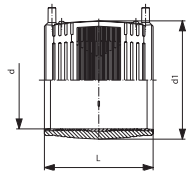

d,

LU

d,		d1	() L
	100,	PN 16, SDR 11	
125*	222700013	154	158
140*	222700014	172	168
160*	222700016	195	180
180	222700018	219	194
200	222700020	244	208
225	222700023	273	224
250	222700025	304	244
280	222700028	340	252
315	222700032	382	268
355	222700036	432	246
400	222700040	487	246
	100,	PN 10, SDR 17	
160*	222702016	186	180
180	222702018	213	194
200	222702020	233	208
225	222702023	261	224
250	222702025	304	244
280	222702028	340	252
315	222702032	382	268
355	222702036	414	246
400	222702040	487	246
450	222702045	522	290
500	222702050	579	290
630	222702063	716	442

90 °, LU

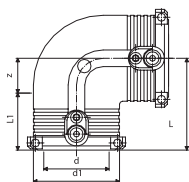

90°, LU
PE 63, PE 80, PE 100, PE?a, WAVIN TS
:
39,5 V

d,		d1	() L	L1	z
	100,		PN 16, SDR 11		
20	222716001	35	54	34	20
25	222716002	35	54	34	20
32	222716003	44	53	36	17
40	222716004	54	62	39	23
50	222716005	66	71	43	28
63	222716007	81	81	48	32

90 °, LU

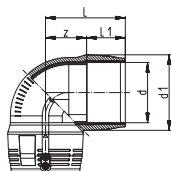

90°, LU

d,		d1	() L	L1	z
	100,		PN 16, SDR 11		
75	222716008	97	101	61	40
90	222716009	115	122	62	60
110	222716011	140	147	72	76
125	222716013	151	142	74	68
160	222716016	196	178	92	86
180	222716018	219	195	95	100

90°, LU

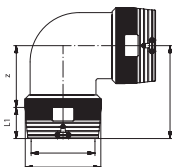

d,		d1	() L	L1	z
	100,		PN 16, SDR 11		
200	222716020	245	265	104	161
225	222716023	274	305	112	193
250	222716025	305	300	123	177

45 °, LU

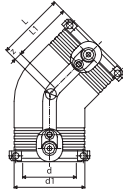

45°, LU

PE 63, PE 80, PE 100, PE?a, WAVIN TS

:

39,5 V

z
z
z
z

d,	d1	() L	L1	z
100,	PN 16, SDR 11			
32	222713003	44	44	36
40	222713004	54	50	39
50	222713005	66	56	43
63	222713007	81	63	48

90 °, LU

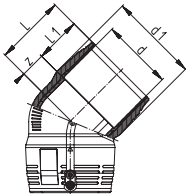

45°, LU

d,	d1	() L	L1	z
100,	PN 16, SDR 11			
75	222713008	97	79	62
90	222713009	115	91	62
110	222713011	140	112	72
125	222713013	151	107	74
160	222713016	196	134	92
180	222713018	217	142	95

45°, LU

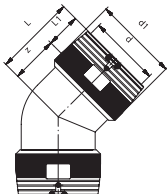

d,	d1	() L	L1	z
100,	PN 16, SDR 11			
200	222713020	245	215	104
225	222713023	274	235	112
250	222713025	305	235	123

LU

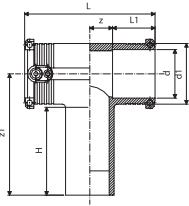

z
z
z
z

LU
PE 63, PE 80, PE 100, PE?a, WAVIN TS
: 39,5 V

d,		d1	() L	L1	z	z1	H
	100,						
			PN 16, SDR 11				
20	222720601	35	90	34	11	92	67
25	222720602	35	90	34	11	92	70
32	222720603	44	102	36	15	100	74
40	222720604	54	120	39	21	114	82
50	222720605	66	135	43	24.5	126	90
63	222720606	81	152	48	28	150	102

LU

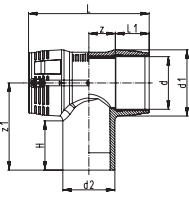

d,

LU

()

d,		d1	() L	L1	z	z1	H
	100,						
			PN 16, SDR 11				
75	222720607	97	187	61	33	126	78
90	222720608	115	205	62	41	161	94
110	222720609	140	255	72	56	180	104
125	222720610	151	256	75	53	174	92
160	222720611	196	325	92	71	230	103
180	222720612	225	344	90	82	250	110

LU

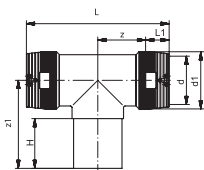

z

()

d,		d1	() L	L1	z	z1	H
	100,						
			PN 16, SDR 11				
200	222720613	245	560	104	176	250	117
225	222720614	274	610	112	193	270	122
250	222720615	305	672	123	213	310	148

LU

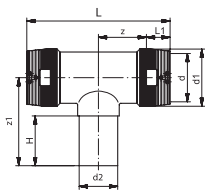

Z
Z
Z
Z
Z

LU
PE 63, PE 80, PE 100, PE?a, WAVIN TS

39,5 V

d/d2,		d1	() L	L1	z	z1	H
	100,	PN 16, SDR 11					
160/63	222785771	196	402	90	111	175	65
160/90	222785772	196	402	90	111	179	79
160/110	222785773	196	402	90	111	201	83
200/90	222785630	245	557	104	175	215	81
200/110	222785631	245	557	104	175	218	84
200/160	222785633	245	557	104	175	236	101
225/90	222785774	274	518	112	147	224	79
225/110	222785775	274	518	112	147	236	83
225/160	222785776	274	518	112	147	246	106
250/110	222785639	305	-	123	-	245	85
250/160	222785640	305	-	123	-	264	101

LU

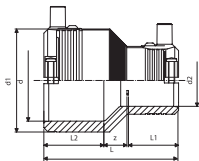

d/d2,

LU

d/d2,		d1	() L	L1	L2	z
	100,	PN 16, SDR 11				
25/20	222740201	35	74	34	34	6
32/20	222740301	44	79	33	36	10
32/25	222740302	44	79	33	36	10
40/32	222740403	54	88	33	39	13
50/32	222740503	66	96	35	43	18
50/40	222740504	66	96	39	43	14
63/32	222740703	81	106	35	48	23
63/40	222740704	81	106	39	48	19
63/50	222740705	81	106	43	48	15

LU

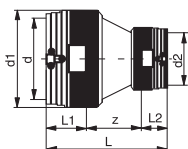

d/d2,

LU

d/d2,		d1	() L	L1	L2	z
	100,	PN 16, SDR 11				
90/63	222740907	112	146	63	47	36
110/90	222741109	136	174	73	63	38
125/90	222741309	152	180	79	61	40
160/110	222741611	196	226	91	70	65
180/125	222741813	220	247	97	70	80

LU

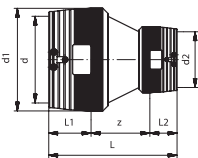

z

LU

d/d2,		d1	() L	L1	L2	z
100,		PN 16, SDR 11				
200/160	222742016	245	322	104	90	128
225/160	222742316	274	352	112	90	150
250/160	222742516	305	348	123	90	135
250/200	222742520	305	354	123	104	127

LU

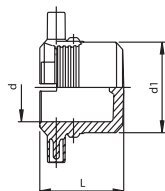

z

LU

PE 63, PE 80, PE 100, PE?a, WAVIN TS

z

:

z

39,5 V

z

d,		d1	() L
100,		PN 16, SDR 11	
20	222750010	35	52
25	222750020	35	52
32	222750030	44	52
40	222750040	54	56
50	222750050	66	60
63	222750070	81	66

LU

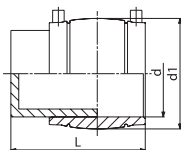

z

LU

d,		d1	() L
100,		PN 16, SDR 11	
75	222750080	95	125
90	222750090	112	140
110	222750110	137	153
125	222750130	156	165
180	222750180	225	228



, LU

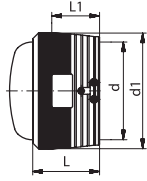

d,	100,	d1	() L	L1
160	222750160	196	129	90
200	222750200	245	147	104
225	222750230	274	157	112
250	222750250	250	173	123

, LU

, LU

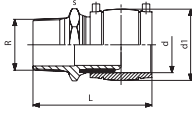

z	?	LU
z	PE 63, PE 80, PE 100, PE?a, WAVIN TS	
z	:	
z	39,5 V	
z		
z		

d?,	100,	d1	() L	s
20 1/2"	222985891	33	97	30
20?"	222985956	33	124	40
25 3/4"	222985892	39	98	35
25?"	222985957	39	124	40
32 1/2"	222985958	46	121	30
32 3/4"	222985959	46	122	35
32?"	222985893	46	105	40
32? 1/4"	222985960	46	107	50
32? 1/2"	222985961	46	107	60
32?"	222985962	46	157	70
40?"	222985963	56	110	40
40? 1/4"	222985894	56	112	50
40? 1/2"	222985964	56	112	60
40?"	222985965	56	157	70
50?"	222985966	69	120	40
50? 1/4"	222985967	69	122	50
50? 1/2"	222985895	69	122	60
50?"	222985968	69	157	70
63?"	222985969	82	151	40
63? 1/4"	222985970	82	127	50
63? 1/2"	222985971	82	127	60
63?"	222985896	82	131	70

LU

?

LU

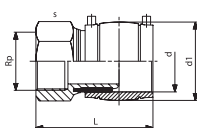

Z
Z
Z
Z
Z

PE 63, PE 80, PE 100, PE?a, WAVIN TS

:

39,5 V

d? p,

d1

()
L

s

	100,	PN 16, SDR 11		
32?"	222985897	46	96	40
40? 1/4"	222985898	56	103	50
50? 1/2"	222985899	69	113	60
63?"	222985890	82	122	40
63? 1/4"	222985901	82	122	50
63? 1/2"	222985902	82	122	60
63?"	222985900	82	122	70

90

°

LU

90°

?

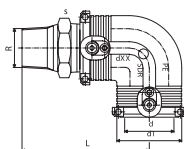

LU

Z
Z
Z
Z
Z

PE 63, PE 80, PE 100, PE?a, WAVIN TS

:

39,5 V

d?,

d1

()
L

s

	100,	PN 16, SDR 11		
20 1/2"	222985911	31	96	30
25 3/4"	222985912	36	97	35
32?"	222985913	44	98	40
32? 1/4"	222985921	44	100	50
32? 1/2"	222985922	44	100	60
40?"	222985923	54	107	50
40? 1/4"	222985914	54	109	50
40? 1/2"	222985924	54	109	60
50?"	222985925	66	116	60
50? 1/4"	222985926	66	118	60
50? 1/2"	222985915	66	118	60
63? 1/4"	222985927	81	128	70
63? 1/2"	222985928	81	128	70
63?"	222985916	81	132	70

90°, LU

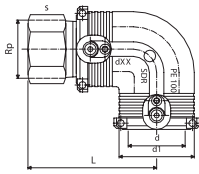

LU
Z
Z
Z
Z
Z

90° ?

PE 63, PE 80, PE 100, PE?a, WAVIN TS

39,5 V

d? p,		d1	() L	s
	100,		PN 16, SDR 11	
32?"	222985917	44	89	40
40? 1/4"	222985918	54	100	50
50? 1/2"	222985919	66	109	60
63?"	222985945	81	123	70
63? 1/4"	222985946	81	123	70
63? 1/2"	222985947	81	123	70
63?"	222985920	81	123	70

? , LU

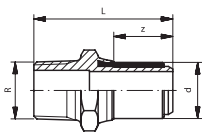

Z
Z

? , LU

WAVIN, LU

d? ,		d1	() L	s
	100,		PN 16, SDR 11	
20 1/2"	222900101	75	28,5	
25 3/4"	222900202	76	28,5	
32?"	222940302	80	31,0	
40? 1/4"	222940403	86	33,0	
50? 1/2"	222940404	90	37,5	
63?"	222940705	98	40,5	

? , LU

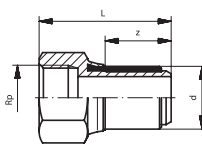

Z
Z

? , LU

WAVIN, LU

d? ,		L	() z
	100,		PN 16, SDR 11
32?"	222950302	71	31,0
40? 1/4"	222950403	77	33,0
50? 1/2"	222950504	81	37,5
63?"	222950705	89	40,5

? , LU

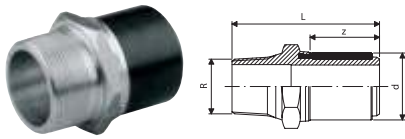

Z
Z

?

, LU

WAVIN, LU

d?, L z ()

	100,	PN 16, SDR 11	
20 1/2"	222985860	75	33
25 3/4"	222985861	76	33
32?"	222985862	80	35
32? 1/4"	222985880	82	35
32? 1/2"	222985881	82	35
40?"	222985882	84	39
40? 1/4"	222985863	86	39
40? 1/2"	222985883	86	39
50?"	222985885	88	43
50? 1/4"	222985884	90	43
50? 1/2"	222985864	90	43
63? 1/4"	222985886	94	47
63? 1/2"	222985887	94	47
63?"	222985865	98	47

? , LU

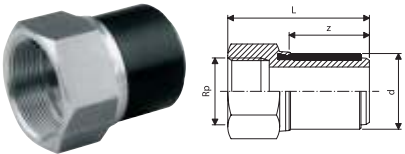

Z
Z

?

, LU

WAVIN, LU

d? p, L z ()

	100,	PN 16, SDR 11	
32?"	222985866	71	35
40? 1/4"	222985867	77	39
50? 1/2"	222985868	81	43
63?"	222985972	89	47
63? 1/4"	222985973	89	47
63? 1/2"	222985974	89	47
63?"	222985869	89	47

, LU

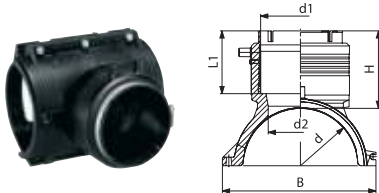

Z
Z
Z
Z

, LU

PE 63, PE 80, PE 100, PE?a, WAVIN TS

39,5 V

d?1, d2 H L L1 B ()

	100,	PN 16, SDR 11		L	L1	B
110?0	222760001	65	101	220	81.5	164
110?10	222760002	65	107	220	87.5	164
125?0	222760003	65	101	220	81.5	179
125?10	222760004	65	107	220	87.5	179
160?0	222760005	65	102	240	81.5	215
160?10	222760006	86	108	240	87.5	215
160?25	222760007	86	129	240	98.5	215
180?0	222760008	65	102	260	81.5	237
180?10	222760009	86	108	260	87.5	237
180?25	222760010	86	129	260	98.5	237

200?0	222760011	65	102	260	81.5	253
200?10	222760012	86	108	260	87.5	253
200?25	222760013	86	129	260	98.5	253
225?0	222760014	65	102	260	81.5	287
225?10	222760015	86	108	260	87.5	287
225?25	222760016	86	129	260	98.5	287
250?0	222760017	65	102	260	81.5	312
250?10	222760018	86	108	260	87.5	312
250?25	222760019	86	129	260	98.5	312

LU

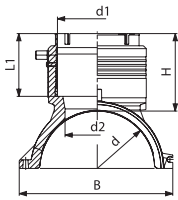

LU
PE 63, PE 80, PE 100, PE?a, WAVIN TS
:
39,5 V

d,	d1,	d2,	() H,	L,	L1,	B,	
	100,		PN 16, SDR 11				
280?15	90	222788140	65	102	260	82	243
280?15	110	222788141	86	108	260	88	243
280?15	125	222788142	86	129	260	99	243
355?50	90	222788143	65	102	260	82	250
355?50	110	222788144	86	108	260	88	250
355?50	125	222788145	86	129	260	99	250
500?30	90	222788146	65	102	260	82	263
500?30	110	222788147	86	108	260	88	263
500?30	125	222788148	86	129	260	99	263

LU

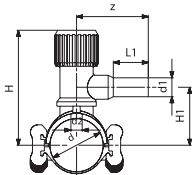

LU
PE 63, PE 80, PE 100, PE?a, WAVIN TS
:
39,5 V

d?1,	d2	H	() H1	L	L1	z	s	
	100,		PN 16, SDR 11					
40?0	222761001	18	133	60	145	53	114	10
40?5	222761002	18	133	60	145	53	114	10
40?2	222761003	18	133	60	145	53	121	10
50?0	222761004	18	138	65	145	53	114	10
50?5	222761005	18	138	65	145	53	114	10
50?2	222761006	18	138	65	145	53	121	10
63?0	222761007	18	145	71	175	53	114	10
63?5	222761008	18	145	71	175	53	114	10
63?2	222761009	32	171	75	175	59	121	19
63?0	222761010	32	171	75	175	59	121	19
63?0	222761011	32	171	75	175	62	131	19
63?3	222761012	32	171	75	175	64	139	19
75?2	222761013	32	177	81	175	59	121	19
75?0	222761014	32	177	81	175	59	121	19
75?0	222761015	32	177	81	175	62	131	19
75?3	222761016	32	177	81	175	64	139	19
90?2	222761017	32	189	93	175	59	121	19
90?0	222761018	32	189	93	175	59	121	19
90?0	222761019	32	189	93	175	62	131	19
90?3	222761020	32	189	93	175	64	139	19

LU

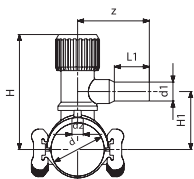

LU

d?1,		d2	H	() H1	L	L1	z	s
	100,	PN 16, SDR 11						
110?2	222761021	32	199	103	175	59	121	19
110?0	222761022	32	199	103	175	59	121	19
110?0	222761023	32	199	103	175	62	131	19
110?3	222761024	32	199	103	175	64	139	19
125?2	222761025	32	207	111	175	59	121	19
125?0	222761026	32	207	111	175	59	121	19
125?0	222761027	32	207	111	175	62	131	19
125?3	222761028	32	207	111	175	64	139	19
160?2	222761029	32	224	128	175	59	121	19
160?0	222761030	32	224	128	175	59	121	19
160?0	222761031	32	224	128	175	62	131	19
160?3	222761032	32	224	128	175	64	139	19
180?2	222761033	32	234	138	175	59	121	19
180?0	222761034	32	234	138	175	59	121	19
180?0	222761035	32	234	138	175	62	131	19
180?3	222761036	32	234	138	175	64	139	19
200?2	222761037	30	244	148	175	59	121	19
200?0	222761038	30	244	148	175	59	121	19
200?0	222761039	30	244	148	175	62	131	19
200?3	222761040	30	244	148	175	64	139	19
225?2	222761041	30	257	161	175	59	121	19
225?0	222761042	30	257	161	175	59	121	19
225?0	222761043	30	257	161	175	62	131	19
225?3	222761044	30	257	161	175	64	139	19

LU

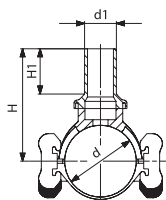

LU

PE 63, PE 80, PE 100, PE?a, WAVIN TS

: 39,5 V

d?1,		H	() H1	L
	100,	PN 16, SDR 11		
50?2	222762001	114	54	145
63?2	222762002	121	54	175
63?0	222762003	128	63	175
75?2	222762004	127	54	175
75?0	222762005	134	63	175
90?2	222762006	140	54	175
90?0	222762007	147	63	175
90?3	222762008	138	65	175
110?2	222762009	150	54	175
110?0	222762010	158	63	175
110?3	222762011	148	65	175
125?2	222762012	157	54	175
125?0	222762013	164	63	175
125?3	222762014	155	65	175
160?2	222762015	175	54	175
160?0	222762016	182	63	175
160?3	222762017	173	65	175
180?2	222762018	185	54	175
180?3	222762019	183	65	175
200?2	222762020	195	54	175
200?3	222762021	193	65	175
225?2	222762022	207	54	175
225?3	222762023	205	65	175

LU

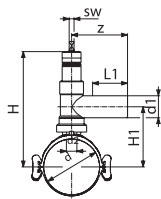

z PE 63, PE 80, PE 100, PE 125, PE 160, PE 200, PE 250, WAVIN TS
 z :
 z 39,5 V
 z
 z 28 /

d?1,		d2	H	() H1	L	L1	z	sw
	100,			PN 16, SDR 11				
90?3	222788449	30	295	137	175	100	160	14
110?3	222788450	30	305	147	175	100	160	14
125?3	222788451	30	312	154	175	100	160	14
160?3	222788453	30	330	172	175	100	160	14
180?3	222788454	30	340	182	175	100	160	14
200?3	222788455	30	350	192	175	100	160	14
225?3	222788456	30	362	204	175	100	160	14

LU



z
 z LU

0,75	222950610
1,00	222950611
1,25	222950612
1,50	222950613

LU



z
 z
 z LU

0,85?05	222950510
1,10?60	222950511
1,30?90	222950512

LU

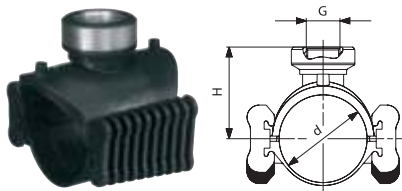

z LU
 z PE 63, PE 80, PE 100, PE?a, WAVIN TS
 z :
 z 39,5 V
 z

d?, H ()
 L

	100,	PN 16, SDR 11	
63? 1/4"	222764073	84	175
75? 1/4"	222764083	90	175
90? 1/4"	222764093	104	175
90? 1/2"	222764094	104	175
110? 1/4"	222764113	114	175
110? 1/2"	222764114	114	175
125? 1/2"	222764134	121	175
160? 1/2"	222764164	139	175
180? 1/2"	222764184	149	175
200? 1/2"	222764204	159	175
225? 1/2"	222764234	171	175

LU

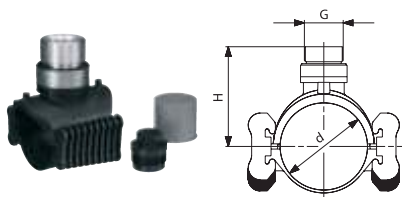

z LU
 z PE 63, PE 80, PE 100, PE?a, WAVIN TS
 z :
 z 39,5 V
 z G 2"
 z

d?, H ()
 L

	100,	PN 16, SDR 11	
90? 1/2"	222764098	148	175
110? 1/2"	222764118	158	175
125? 1/2"	222764138	165	175
160? 1/2"	222764168	183	175
180? 1/2"	222764188	193	175
200? 1/2"	222764208	203	175
225? 1/2"	222764238	215	175

C



?
?
?
?
?
?
?
?
?
?
?
? AVK:

FUTURE K1
Wavin Ekoplastik

? 315 ? 1000
()

« »
« » ?